

European Narrow-type Electric Strike

Specification

Model	Size	Voltage	Current	Feature	Suitable for	Weight
ED113412	110Lx24Wx28.5H	DC12V	12V/280mA	Fail Secure(NO)	Woodeng door Metal door	0.28 kg
ED113424	110Lx24Wx28.5H	DC24V	24V/160mA	Fail Secure(NO)	Woodeng door Metal door	0.28 kg
ED1134B12	120Lx24Wx31H	DC12V	12V/280mA	Fail Secure(NO)	Woodeng door Metal door	0.28 kg
ED1134B24	120Lx24Wx31H	DC24V	24V/160mA	Fail Secure(NO)	Woodeng door Metal door	0.28 kg

Diagram(unit:mm)

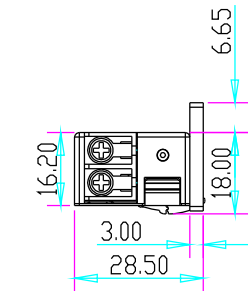

ED113412/ED113424

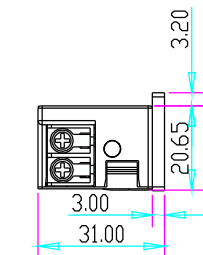
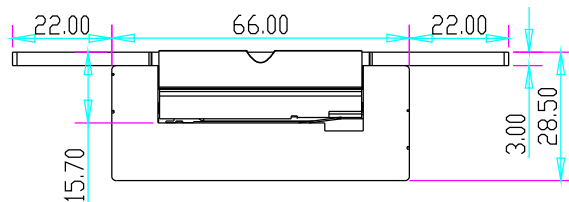
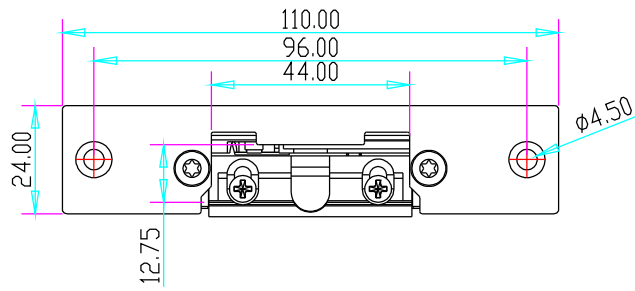

ED1134B12/ED1134B24

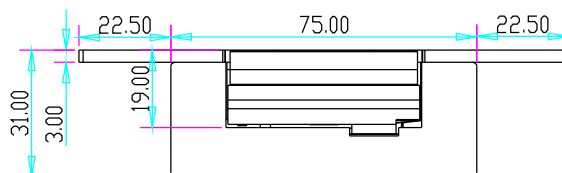
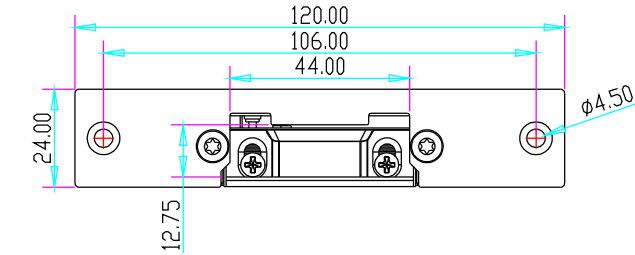

Installation

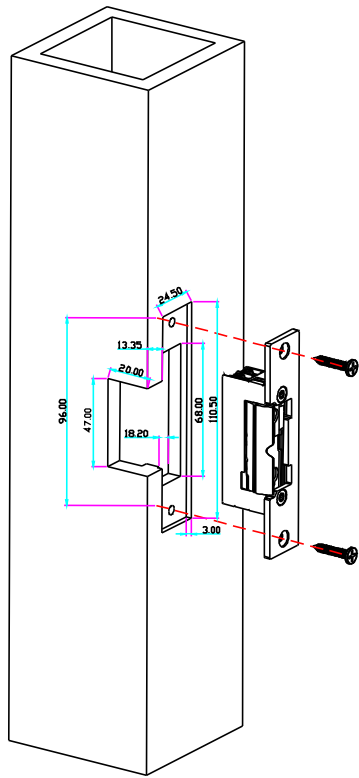

ED113412/ED113424

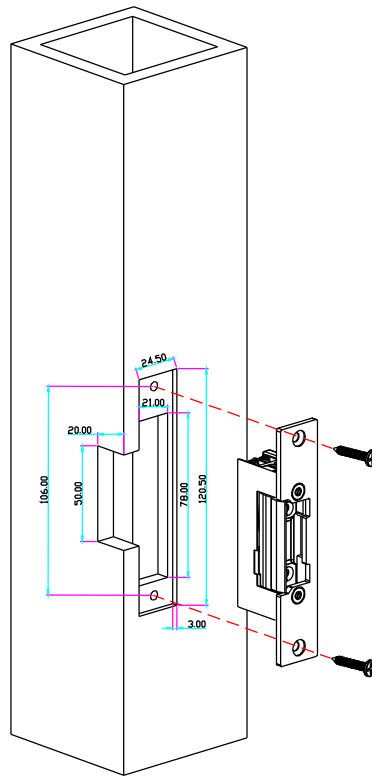

ED1134B12/ED1134B24

Wire connection

